

167mm Cill Extension 110.107
Steel Reinforcement 113.048
Aluminium Reinforcement 115.105
End Cap 109.136
Cill Joint 109.366

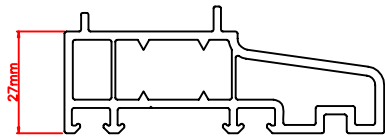

85mm stub cill extension 110.060
reinforcement 113.020
(end cap 109.368)

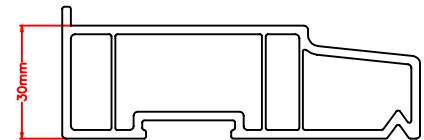

95mm stub cill extension 110.074
reinforcement 113.377
(end cap 109.074)

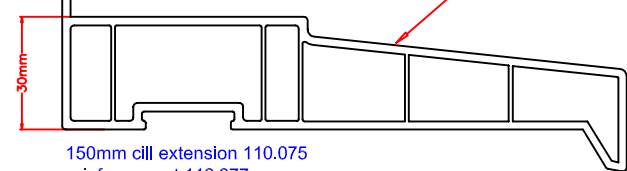

150mm cill extension 110.075
reinforcement 113.377
(end cap 109.075)

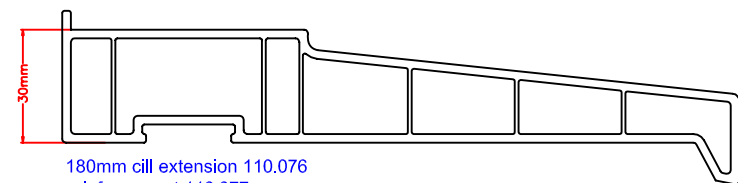

180mm cill extension 110.076
reinforcement 113.377
(end cap 109.090)

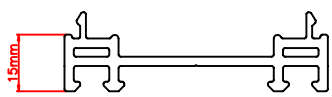

15mm frame extension 114.028

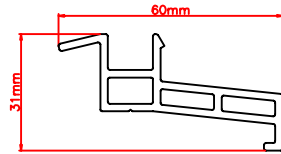

32.5mm cill frame extension 110.028

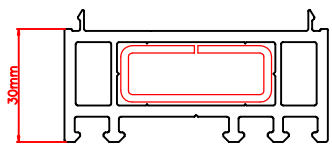

30mm frame extension 114.014
Reinforcement 113.035

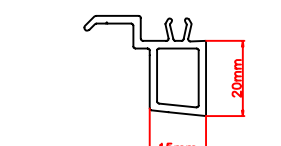

cill frame extension 110.048

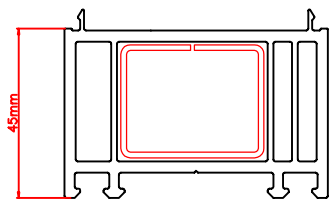

45mm frame extension 114.202
Reinforcement 113.271

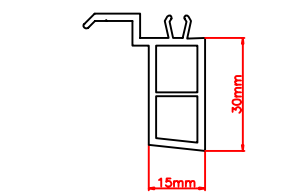

cill frame extension 110.047

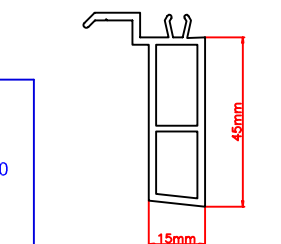

cill frame extension 110.046

Note:-
90° cill joint moulding
135° cill joint moulding
180° cill joint moulding
For the 150mm cill extension only



Bead Groove Infill 112.380



Eurogroove Infill 109.045

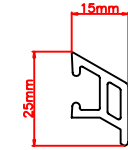

Drip Mould 109.030
End Cap 109.140

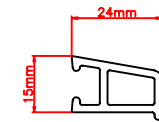

Drip Mould 109.122
End Cap 109.141

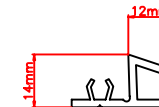

12mm Snap On Bead 109.115

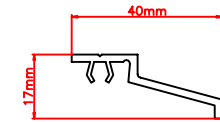

Snap On Head Drip 109.230

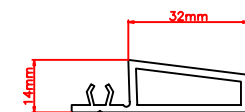

32mm Snap On Bead 109.231

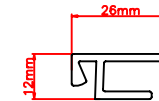

8mm Board Receiver 109.286

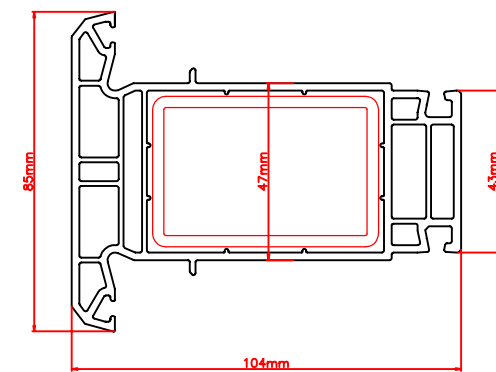

Coupling Profile 116.202
Steel Reinforcement 113.011

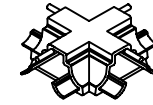

Cruciform 109.113

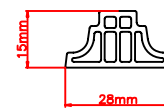

Georgian Bar 109.114

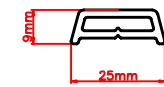

Georgian Bar 109.275

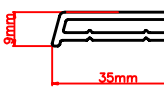

Georgian Bar 109.276

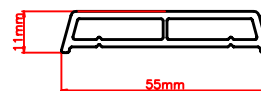

Georgian Bar 109.277

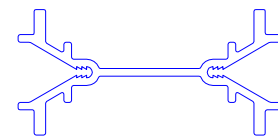

20mm Aluminium Coupling 104.210



PVC Cover 116.060

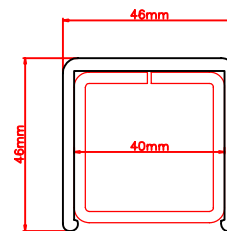

Cover Profile 109.195
Steel Reinforcement 113.128
Aluminium Reinforcement 115.089
Aluminium Reinforcement 115.014

Georgian Bars

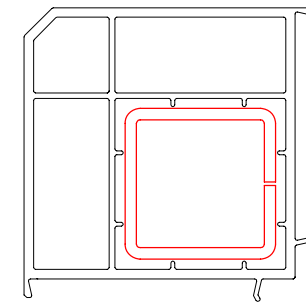

90° Corner Post 116.200
Steel Reinforcement 113.128
Aluminium Reinforcement 115.014
Adjustment Nut 141.444

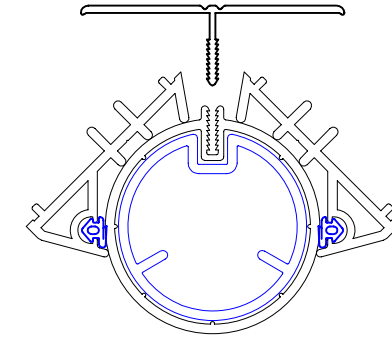

Bay Pole Cover 116.047
Aluminium Bay Pole 104.157
Bay Pole Shoe 116.049
Gasket 112.003
Cover Piece 116.048
Adjustment Nut 141.437

Bay Poles

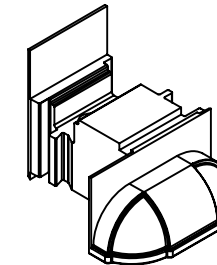

False Mullion End Cap Moulding
109.525 LH/RH
(for 102.265)

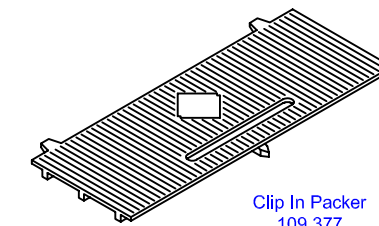

Clip In Packer
109.377

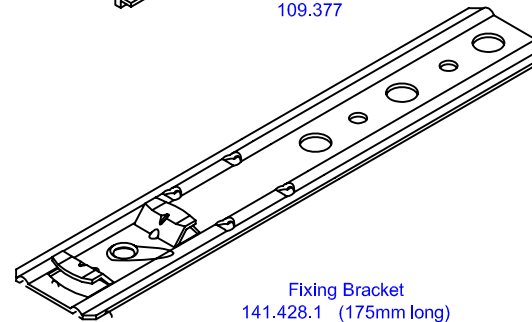

Fixing Bracket
141.428.1 (175mm long)
141.428.2 (200mm long)
141.428.3 (250mm long)

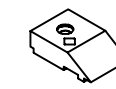

Casement Run-up Block
109.380

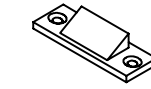

Cavity Locking Wedge
109.265

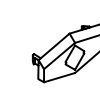

Drain Slot Cover
109.267

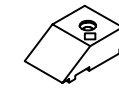

Tilt & Turn / Door Run-up Block
109.398

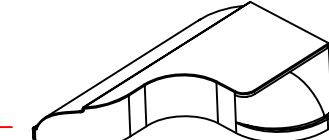

Casement Horn Cover Moulding
109.549 LH/RH

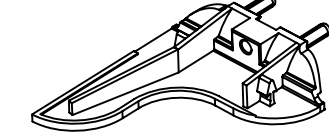

Casement Horn Base Moulding
109.539 LH/RH

Used on Sash
103.264

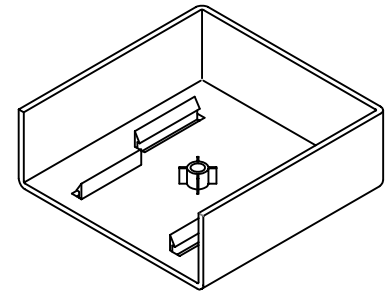

Corner Protector 143.060



Shoot Bolt Keep Plate
141.126

Frame & Cill Extensions

Drips & Beads



Mini Couplings

Frame Couplers

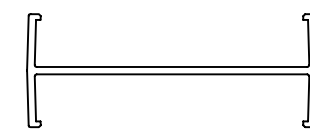

Small H Coupling 116.058

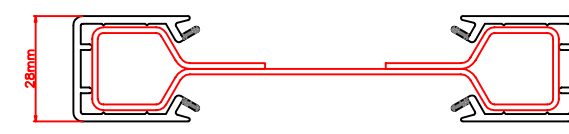

Dog Bone Coupling 113.112
Cover 116.012

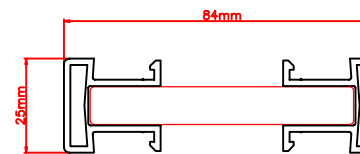

Coupling Cover 116.029
Reinforcement 113.119 (solid)

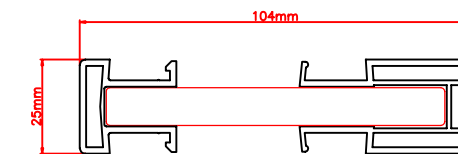

Coupling Covers 116.028 & 116.029
Reinforcement 113.121 (solid)



Sculptured 70 Ancillary Chart